

Spherical roller bearings, cylindrical and tapered bore

Principal dimensions			Basic load ratings		Speed ratings		Designation
d	D	B	dynamic C	static C0	Reference speed	Limiting speed	
mm			kN		r/min		* SKF Explorer bearing
120	215	76	732	930	2000	2800	23224 CCK/W33 *

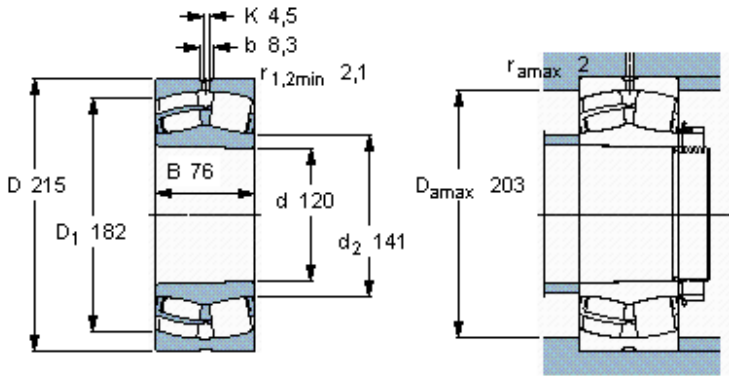

Tapered bore, taper
1: 12

Calculation factors

- e 0,35
- Y_1 1,9
- Y_2 2,9
- Y_0 1,8